

TR9058 - TR9058K

TELAJETTO LATERALE SPECIFICO - SPECIFIC SADDLEBAG TUBULAR HOLDER - SUPPORT TUBULAIRE POUR SACOCHES CAVALIÈRES - SPEZIAL SEITENTRAEGER FUER WEICHTASCHEN - PORTA ALFORJAS TUBULAR LATERAL - SUPORTE LATERAL DE ALFORGES

ROYAL ENFIELD SUPER METEOR 650 (2023)

N°	Descrizione/Description	Caratteristiche/Features	Codice/Code	Quantità/Quantity
1	REMOVE X	-	Z3135DXM Z3135SXM	2 (Right; Left)
2	Telaio laterale - Side frame - Châssis latéral Soporte lateral - Seitenrahmen - Suporte lateral	-	TR02DXV TR02SXV	2 (Right; Left)
3	Supporto - Support - Support - Halterung Soporte - Apoio	-	GL5509DXV GL5509SXV	2 (Right; Left)
4	Vite - Screw - Vis - Schraube Tornillo - Parafuso	TES M10x65	1065TES	2
5	Vite - Screw - Vis - Schraube Tornillo - Parafuso	TSP M8x75	875TSP	2
6	Vite - Screw - Vis - Schraube Tornillo - Parafuso	TBEIFL M6x20	620TBEIFL	4
7	Rondella Inox - Stainless Steel Washer Rondelle Inox - Rostfreie Unterlegscheibe Aus Stahl Arandela Inox - Arruela Lisa De Aço Inox	Foro Ø10mm / Esterno Ø1mm	101RON	2
8	Rondella - Washer - Rondelle - Scheibe Arandela - Arruela	Foro Ø9mm / Esterno Ø15,5mm / Sp. 4mm	V230	2
9	Distanziale - Spacer Entretoise - Distanzstueck Distanciador - Espaçador	Ø24x18 Foro 10,5mm	C24L18F10,5T	2
10	Distanziale - Spacer Entretoise - Distanzstueck Distanciador - Espaçador	Ø16x27 Foro 8,5mm	C16L27F8,5T	2
11	Distanziale - Spacer Entretoise - Distanzstueck Distanciador - Espaçador	-	V1107	4
12	Dado - Bolt - Ecrou Mutter - Tuerca - Porca	Dado Auto Bloccante Flangiato M8 (H.9,5mm)	8DADIFN	2
13	Dado - Bolt - Ecrou Mutter - Tuerca - Porca	Dado Auto Bloccante Flangiato Basso M6 (H.7mm)	6DADIABFN	4
14	Tappo - Cap Fiche - Stecker Enchufe - Capa	-	17COP	2
15	Tappo - Cap Fiche - Stecker Enchufe - Capa	-	10COP	4
16	Componenti Originali - Original Parts Parties Originales - Original Bauteile Componentes Originales - Componentes Originais	-	-	-

IT_ Nel caso in cui sulle viti originali sia presente del frenafili, ripristinarlo durante il montaggio dell'accessorio.

EN_ If there is threadlocker on the original screws, use threadlocker when mounting the accessory.

DE_ Falls sich auf den Originalschrauben Schraubensicherungsstoff befand, sollte dieser auch bei der Montage des Zubehörs wieder aufgetragen werden

FR_ Si du frein filet est présent sur les vis d'origine, l'appliquer également lors du montage de l'accessoire

ES_ En caso de que el fijador de roscas se encuentre presente en los tornillos originales, colocarlo nuevamente en el montaje del accesorio

PT_ Se houver trava rosca nos parafusos originais, inserir novamente durante a montagem do acessório

TR9058 - TR9058K

TELAJETTO LATERALE SPECIFICO - SPECIFIC SADDLEBAG TUBULAR HOLDER - SUPPORT TUBULAIRE POUR SACOCHES CAVALIÈRES - SPEZIAL SEITENTRAEGER FUER WEICHTASCHEN - PORTA ALFORJAS TUBULAR LATERAL - SUPORTE LATERAL DE ALFORGES

ROYAL ENFIELD SUPER METEOR 650 (2023)

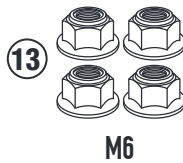
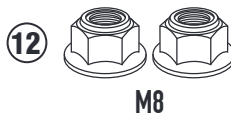
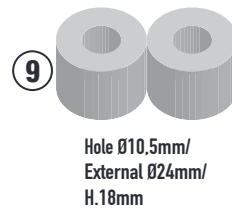
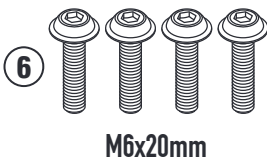
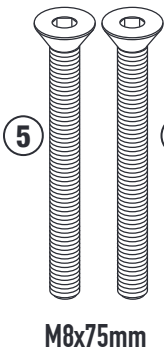
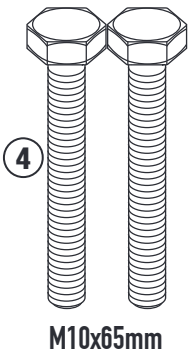
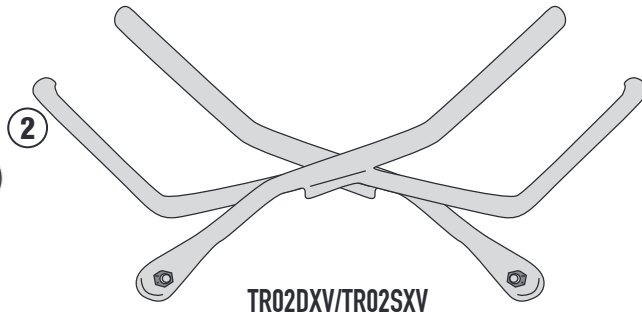
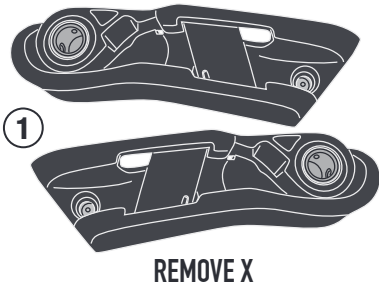

IT_ NON AGGRAPPARSI AI TELAIETTI REMOVE-X
 EN_ Do not hold on to REMOVE-X frames
 FR_ Ne pas s'agripper aux supports REMOVE-X
 ES_ No agarrarse a los soportes REMOVE-X
 DE_ Nicht an dem REMOVE-X Tragrahmen festhalten
 PT_ Não segurar aos suportes REMOVE X

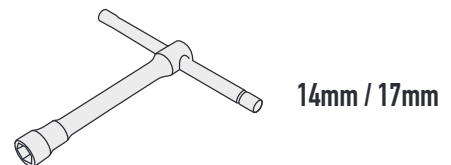
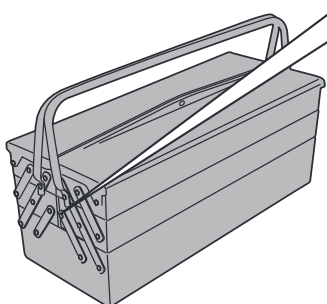

CHECK THE SCREW LENGTH HERE

ISTRUZIONI DI MONTAGGIO - MOUNTING INSTRUCTIONS
 INSTRUCTIONS DE MONTAGE - BAUANLEITUNG
 INSTRUCCIONES DE MONTAJE - INSTRUÇÕES DE MONTAGEM